

Article number: 51030411000010

Description: Vibration damper GS-M2
90x45x2000-10, NR shore 57

Measures

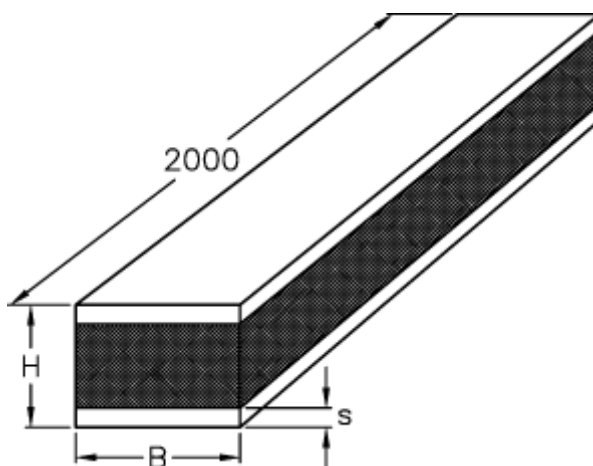

B = 90
H = 45
S = 10